

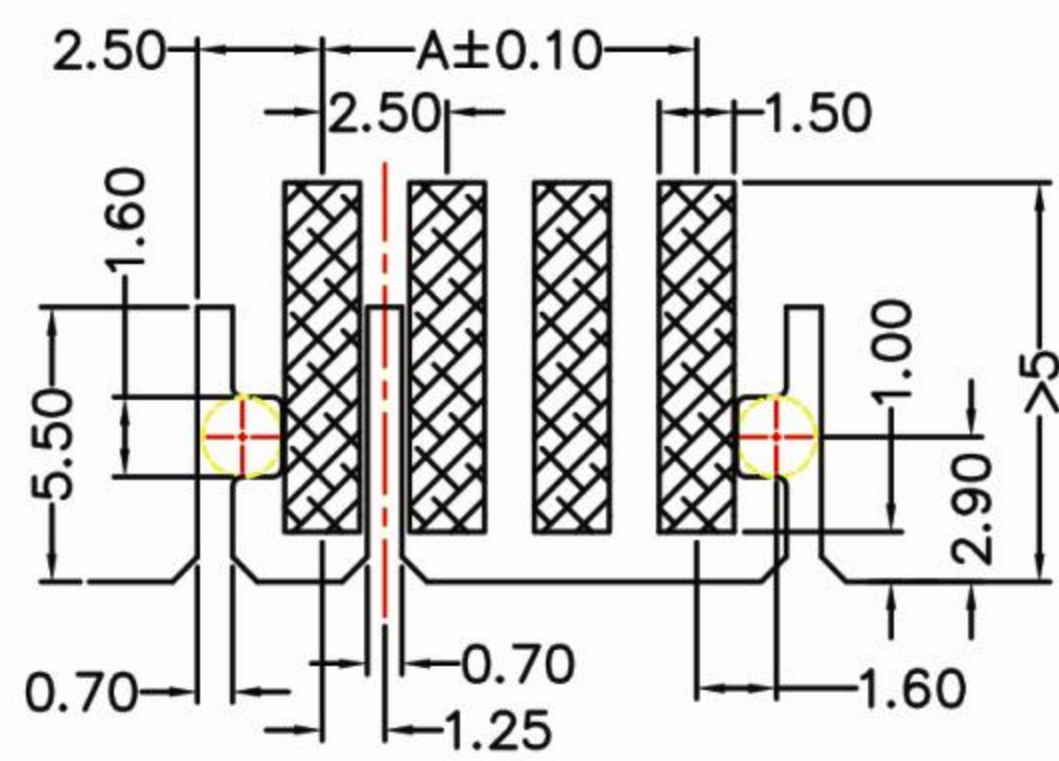

Shenzhen Hongru Connector Co., Ltd

Email: yukyli@hrb-connector.com
 Tel: 86-0755 2709 6669
 Fax: 86-0755 2709 2392
 Skype: haiyuncheng-vivian
 Mobile(whatsapp): 86-186 8112 3590
 Website: http://www.hrb-connector.com/

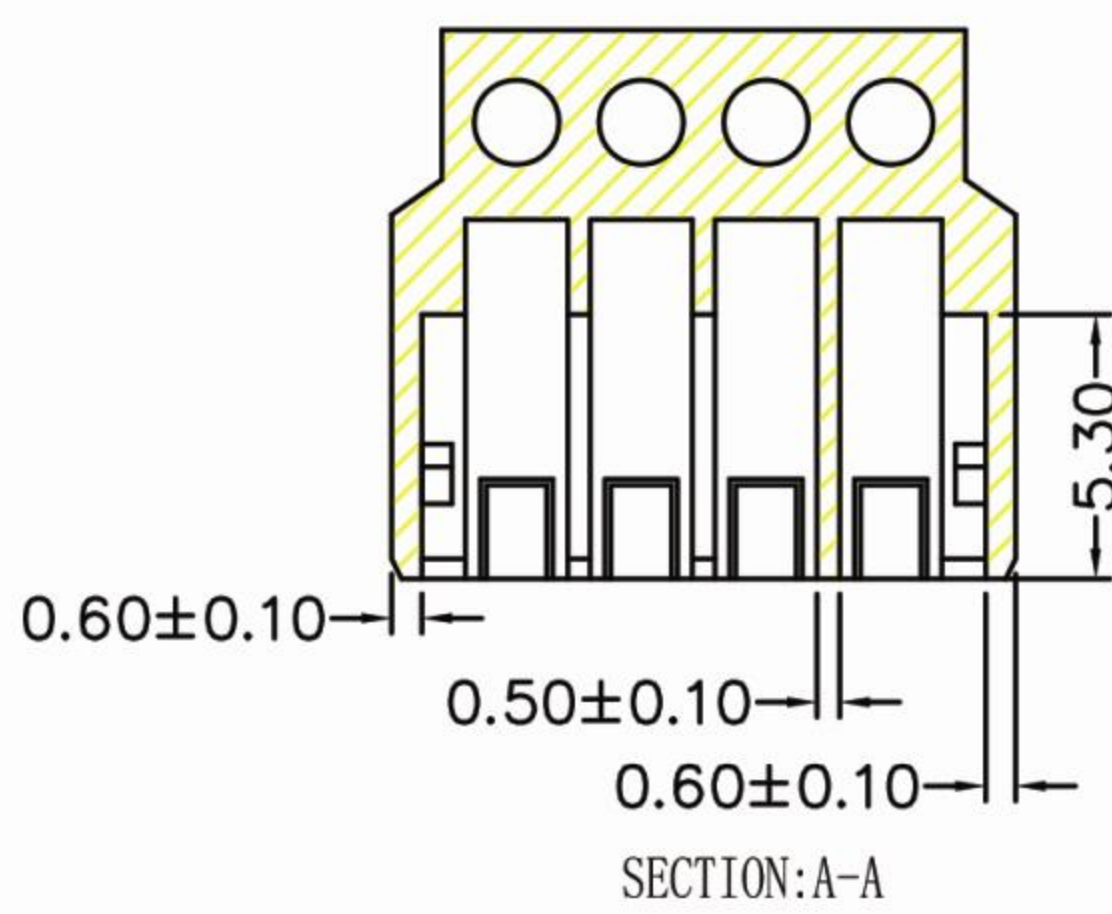
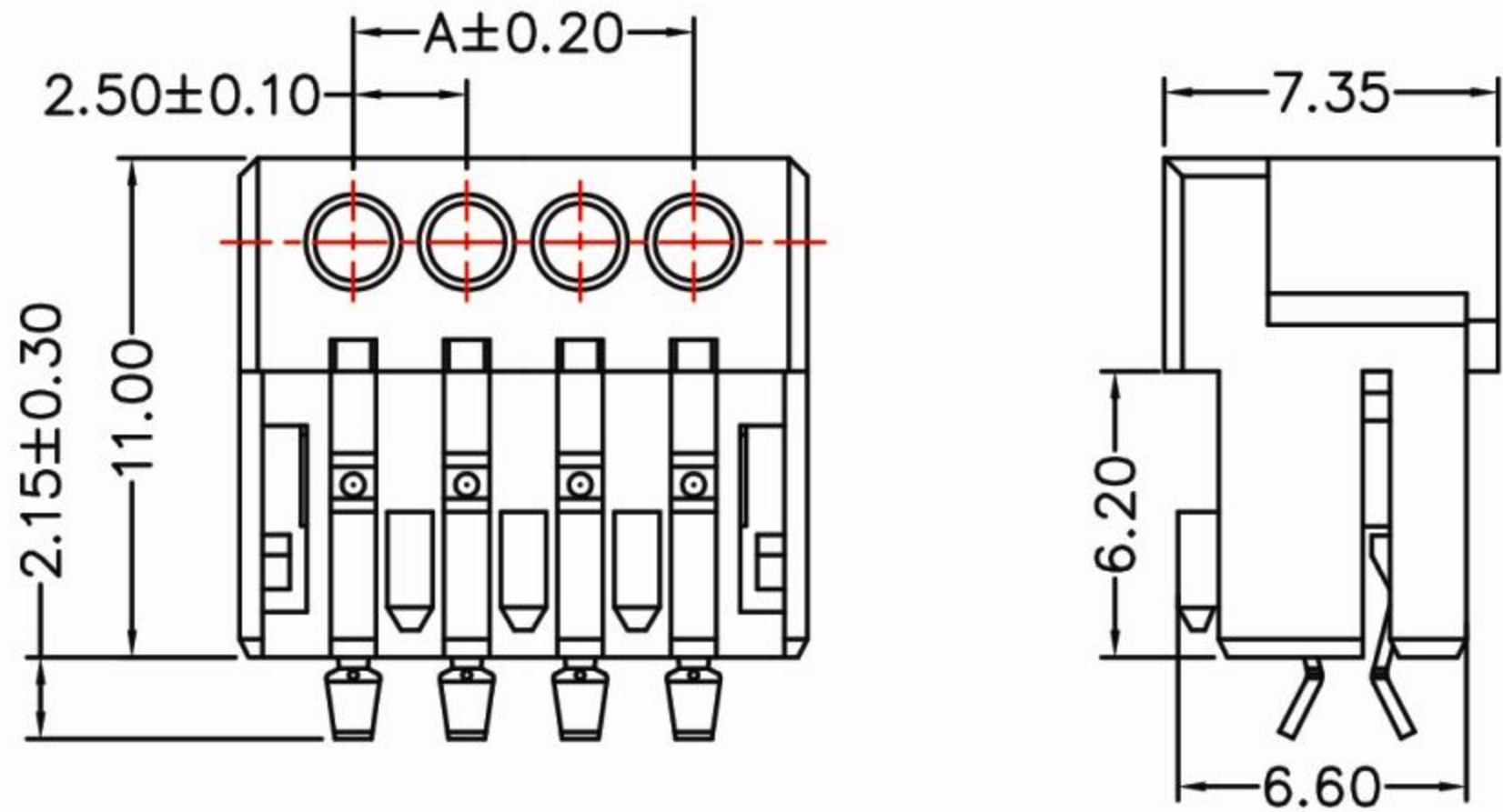
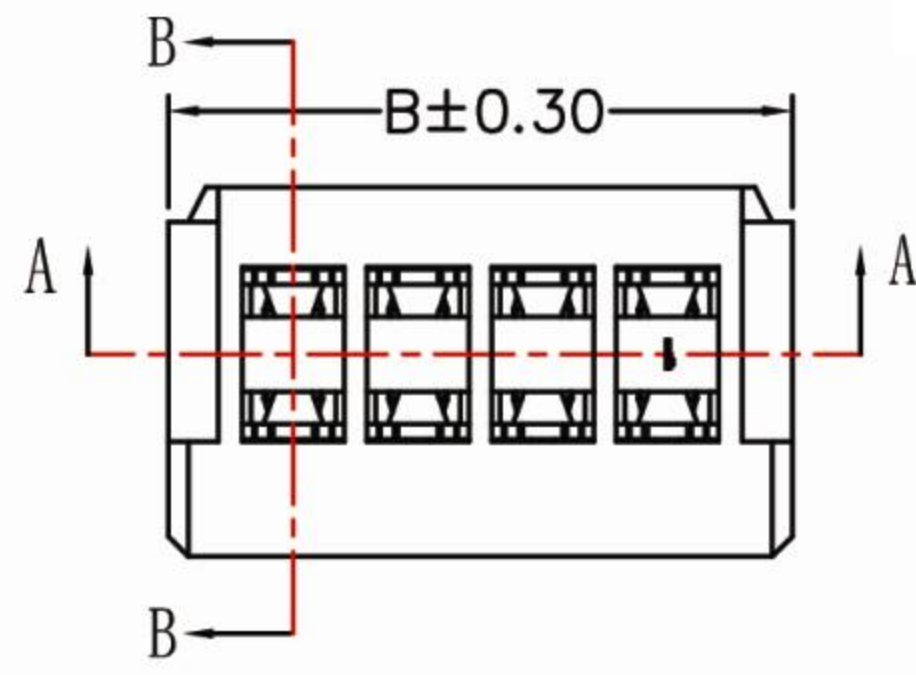

P. C. Board layout

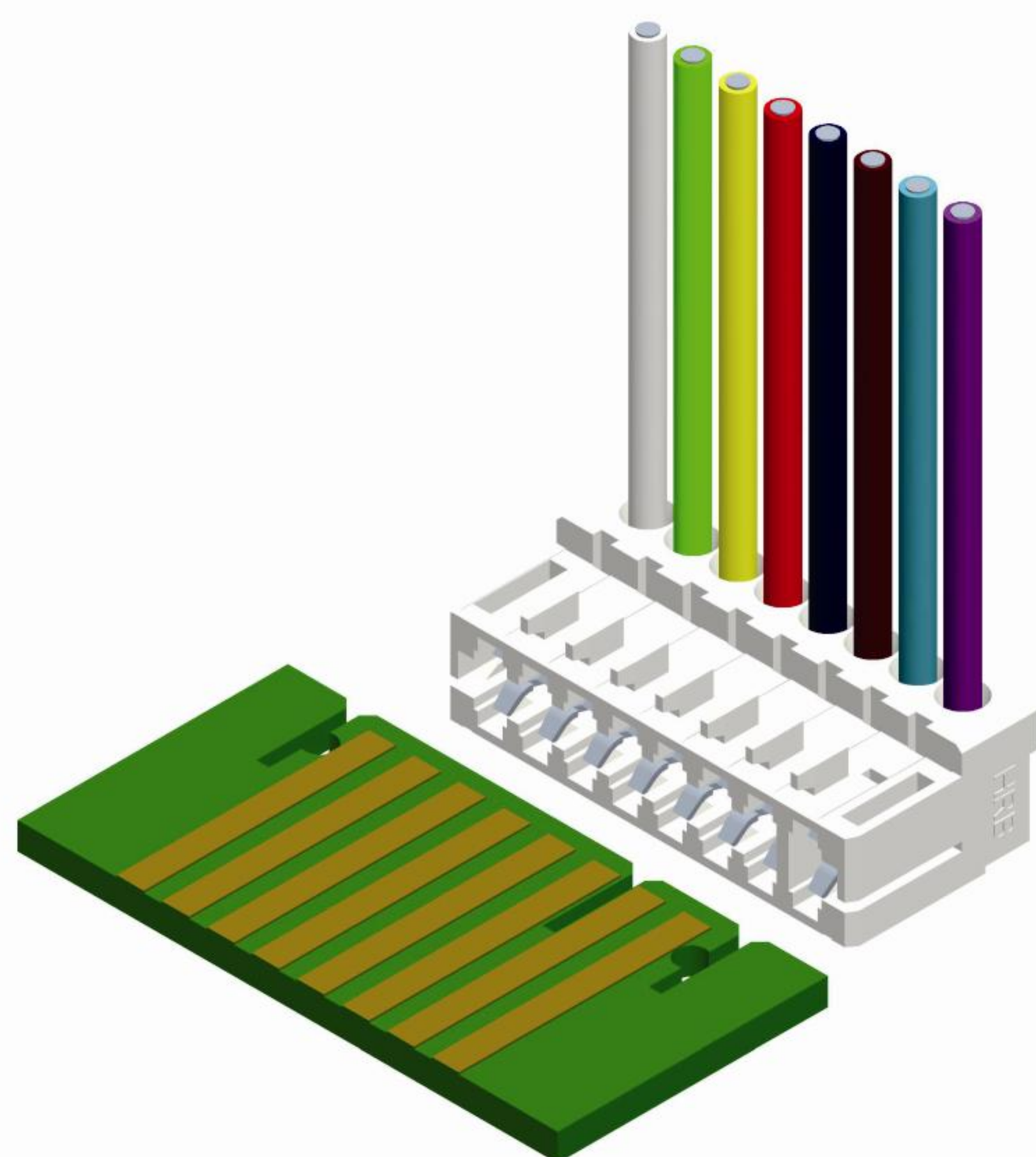

M7239

M7239R

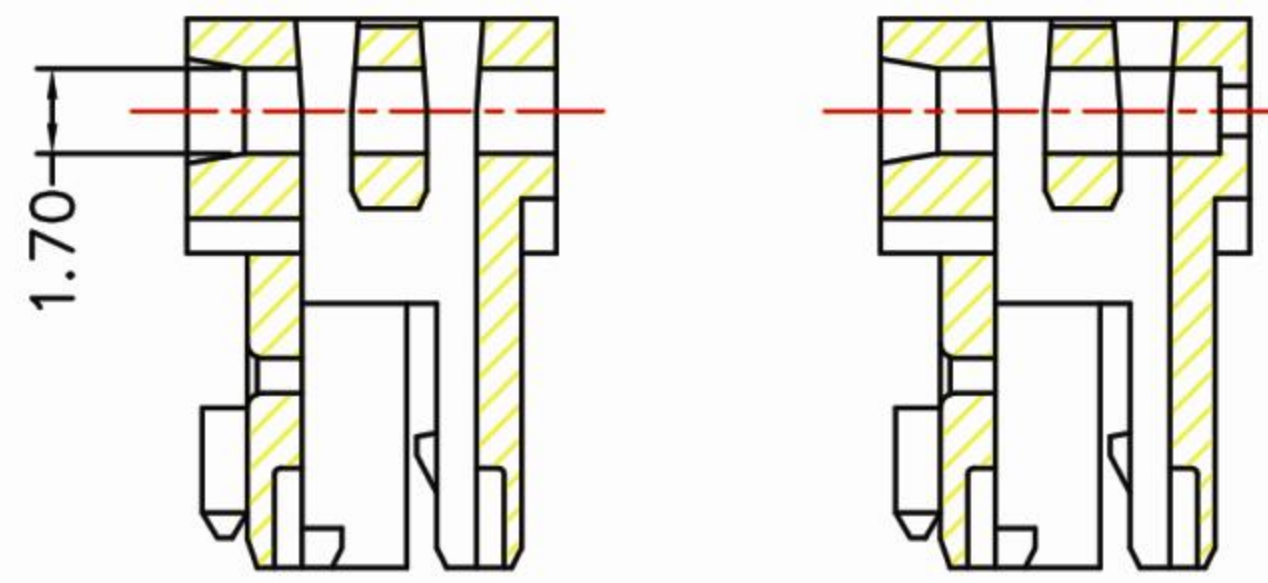

SECTION: B-B

SPECIFICATION

Current rating: 3AAC, DC
 Voltage rating: 32V AC, DC
 Operating Temperature: -40°C--+120°C
 Contact Resistance: 10mΩ max.
 Insulation resistance: 1000MΩ min.
 Withstanding voltage: 1400V AC/minute
 Material: Housing: Nylon66 UL94V-0
 Terminal: Phosphor bronze, Tin-plated
 Wire range: AWG 24 to 22
 GWT: 750°C IEC-60335-1

Dimension		
Circuit No.	A	B
2	2.5	7.5
3	5.0	10.0
4	7.5	12.5
5	10.0	15.0
6	12.5	17.5
7	15.0	20.0
8	17.5	22.5
9	20.0	25.0
10	22.5	27.5
11	25.0	30.0
12	27.5	32.5
13	30.0	35.0
14	32.5	37.5
15	35.0	40.0
16	37.5	42.5
17	40.0	45.0
18	42.5	47.5
19	45.0	50.0
20	47.5	52.5

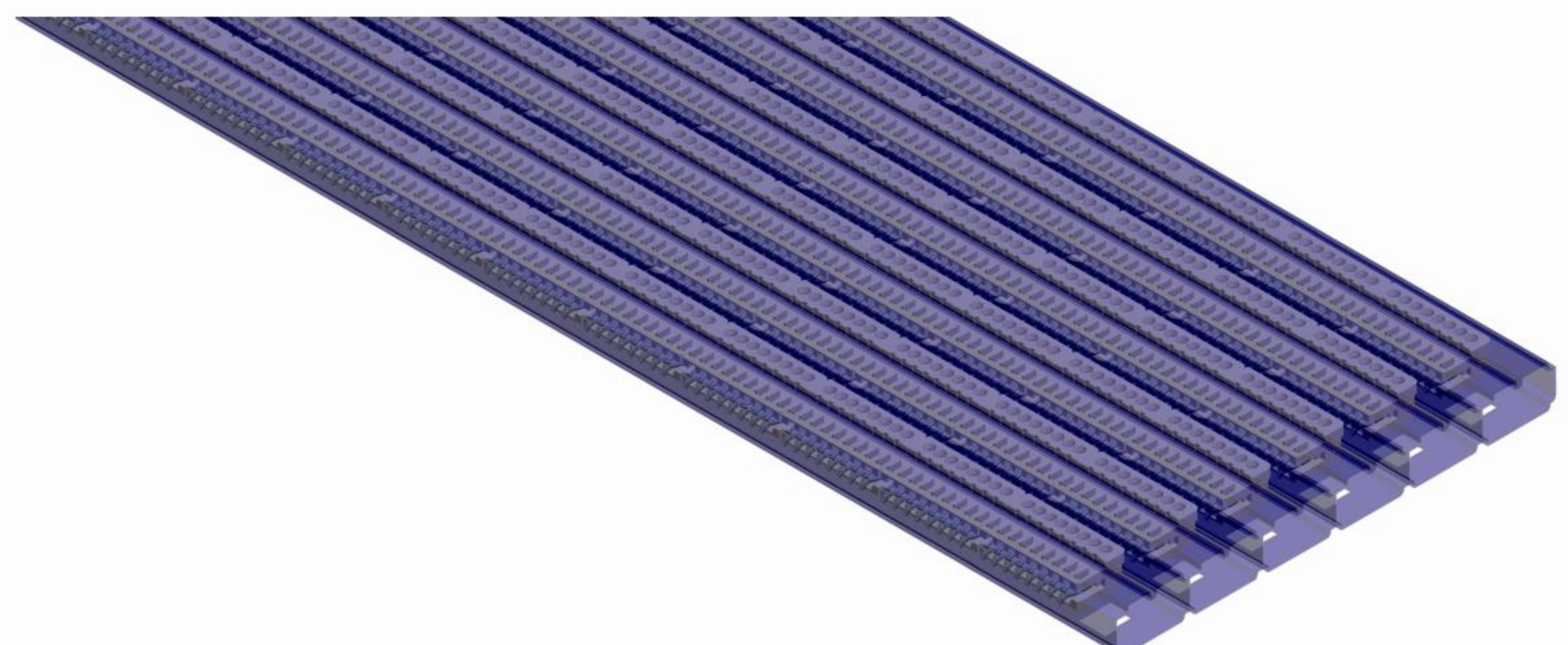



M7239 Series coding chart

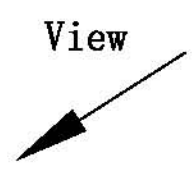
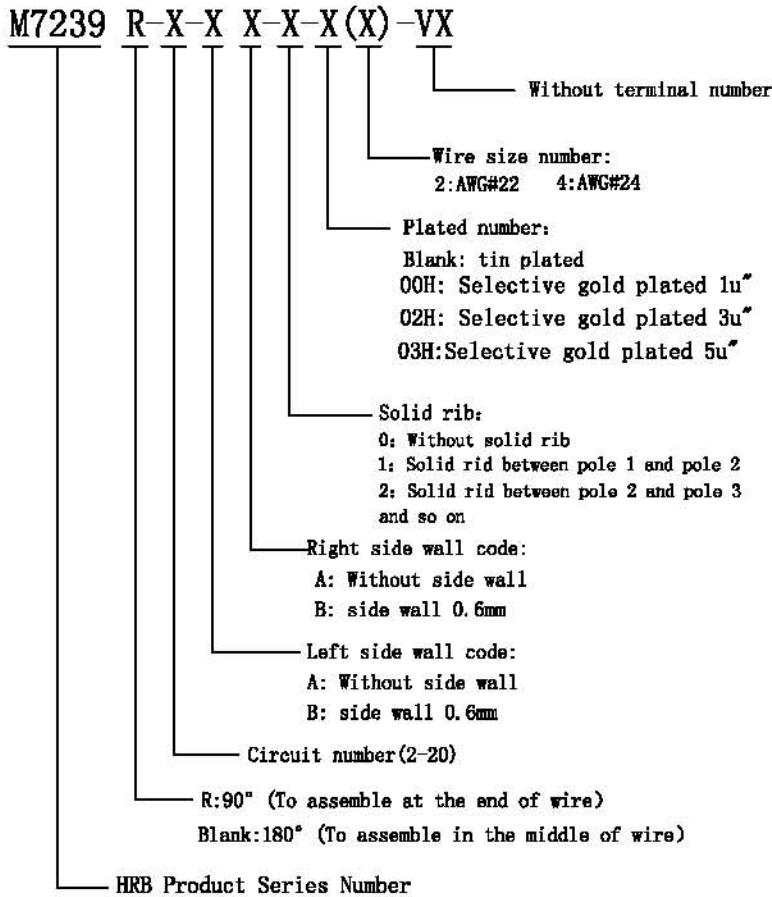

Terminal

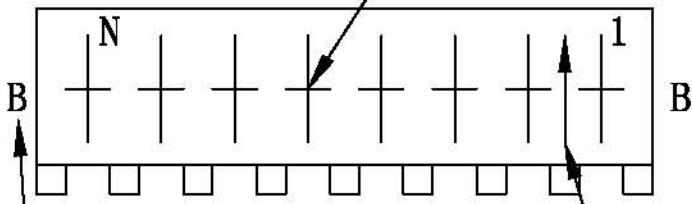
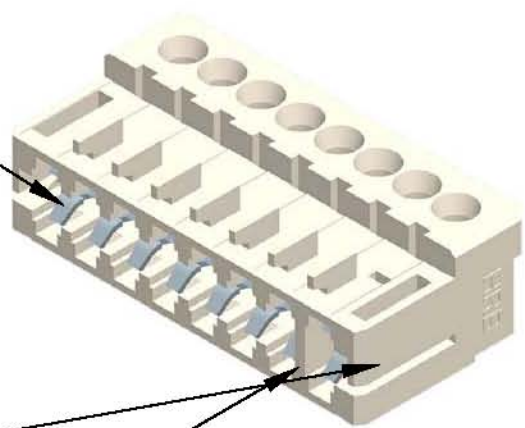

Side wall

Solid rib

The following part numbers are the ones that have been producing in HRB. Of course, we can adjust the fool-proof positions and circuits of product to define some new part numbers and produce.

You're welcome to choose our product!

2 Circuits

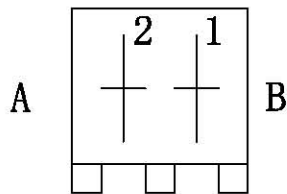

M7239R-2-AB-0 (2)

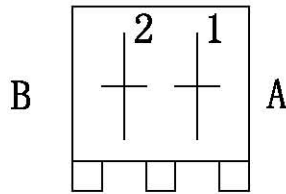

M7239R-2-BA-0 (2)

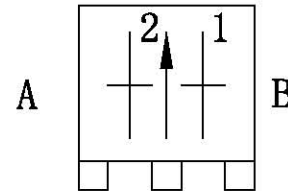

M7239R-2-AB-1 (2)

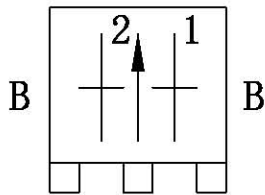

M7239R-2-BB-1 (4)

3 Circuits

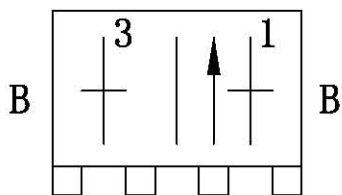

M7239R-3-1 (4)-V1

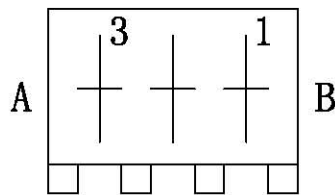

M7239R-3-AB-0 (4)

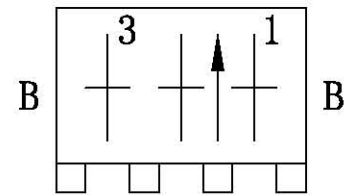

M7239R-3-BB-1 (2)

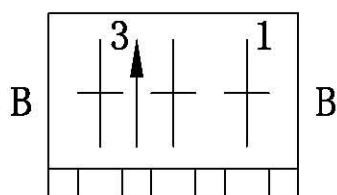

M7239R-3-BB-2 (2)

4 Circuits

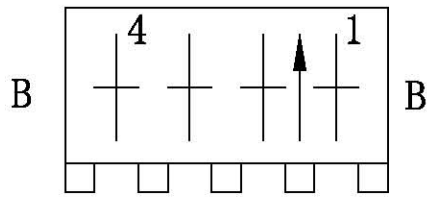

M7239R-4-BB-1 (2)

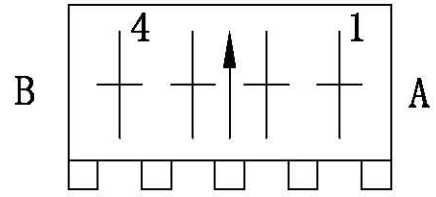

M7239R-4-BA-2 (2)

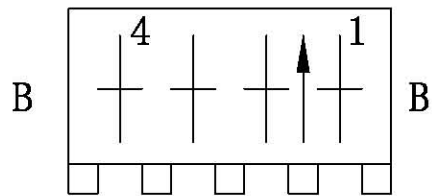

M7239R-4-BB-1 (4)

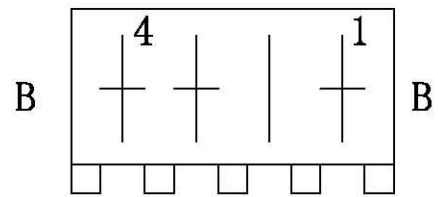

M7239R-4-BB-0 (4) -V1

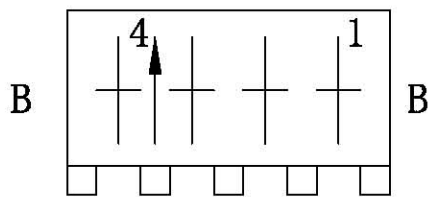

M7239R-4-BB-3 (2)

5 Circuits

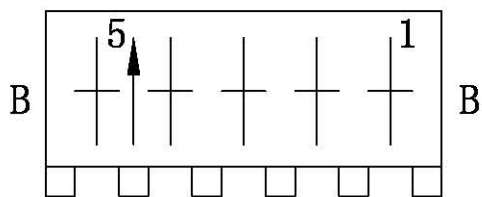

M7239R-5-BB-4 (2)

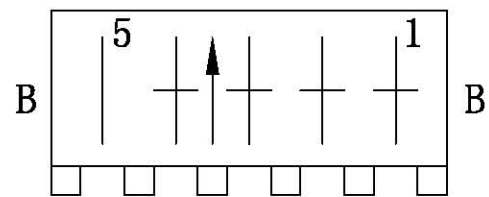

M7239R-5-BB-3 (2) -V1

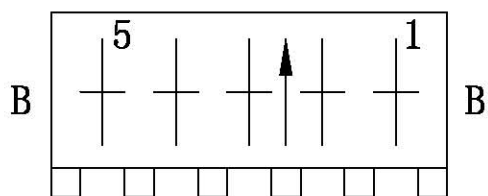

M7239R-5-2 (4)

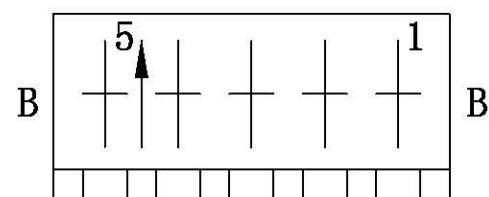

M7239R-5-BB-4 (4)

6 Circuits

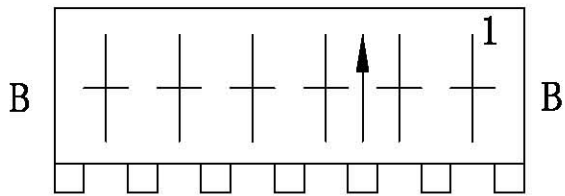

M7239R-6-BB-2 (4)

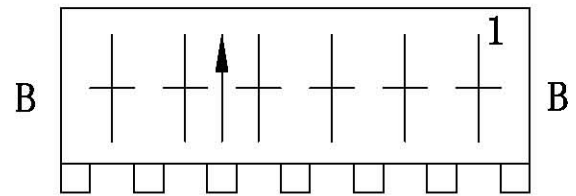

M7239R-6-BB-4 (2)

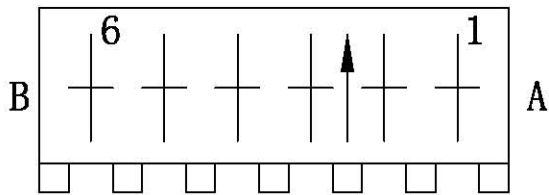

M7239R-6-BA-2 (2)

7 Circuits

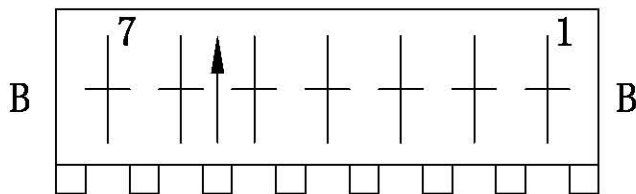

M7239R-7-BB-5 (2)

10 Circuits

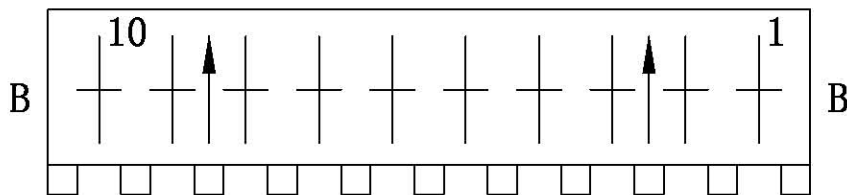

M7238R-10-BB-0208 (2)

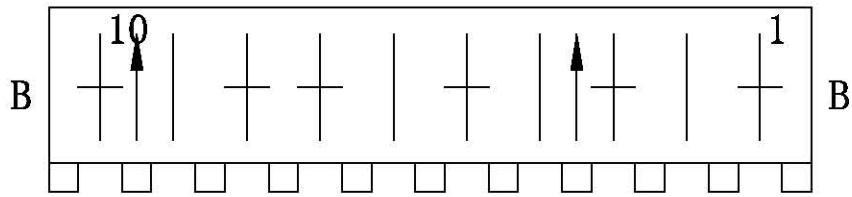

M7238R-10-BB-0309(2)-V4